

THE *Open* GROUP

Interoperable Enterprise Business Scenario



Copyright © 2002 The Open Group.
All rights reserved.

No part of this publication may be reproduced, stored in a retrieval system, or transmitted, in any form, or by any means, electronic, mechanical, photocopying, recording, or otherwise, without the prior permission of the copyright owners.

All brand, company and product names are used for identification purposes only and may be trademarks that are the sole property of their respective owners.

1 Preface

The Open Group is working to deliver its' vision of "Boundaryless Information Flow achieved through global interoperability in a secure, reliable and timely manner" .

One of the key drivers in the development of that vision was the need, articulated by members of The Open Group and others, to "create a worldwide market for interoperable IT products supporting access to integrated information, in which all stakeholder needs are addressed." This paper details the findings and the process

The Business Scenario tool¹ was used to capture a full description of the end-to-end business problem including the whole environment and the business processes, business issues, business users, as well the technical components. The process then captures specific IT-related problems in context to the whole environment. The workshop participants detail this information, and then identify and structure standards-based approaches to eliminating the problems. This is an exercise that can deliver to CIOs and CTOs real understanding of the problem in meaningful terms: the business value of a solution to the problem.

The Scenario itself describes the problem caused by the lack the right information to the right person at the right time (in technical terms, a lack of interoperability); preventing organizations form achieving their business objectives. The Scenario will be used as the basis for achieving agreement to the business issues. And to drive towards standards-based solutions that IT suppliers can deliver to their customers.

The Open Group works with CIOs and CTOs empower a team of champions to work in setting the standards agenda to address these problems.

As a technology-neutral forum for both customers and vendors, The Open Group is ideally positioned to facilitate effective dialog between the buy side and supply side of the IS industry. It is unique in underpinning the results of standards efforts - both its own and those of other standards bodies - with a world-class product certification program.

2 Executive Summary

2.1 Business Scenarios—Why?

In the information age, many enterprises have passed the point where information technology merely supports or enables the business – increasingly, information is the business. Hence the call for Boundaryless Information Flow.

This Scenario addresses the issue of integrated information, and access to that information, in order to support the many different business processes of the enterprise - both internal and external, spanning the key interactions of suppliers, customers, and partners. The title "Boundaryless Information Flow" connotes the end state vision of addressing the above issue.

The main technical challenge in addressing this problem is the lack of interoperability between the different systems that generate and provide access to the data, and of the underlying IT infrastructure, whether these are based on Common Off-The-Shelf (COTS) products or custom-built solutions.

Customers still need to be able to choose best-of-breed solutions for each business application area and for the supporting IT infrastructure, and expect it all to “just work”. To have the necessary information flow between systems without incurring huge integration costs.

Instead, they are often forced into unacceptable choices:

Selecting entire product suites with less than optimal functionality, in the hope that the components of the suite will at least interoperate;

Buying non-interoperable products, with the resulting high integration cost and the on-going cost of maintaining the resulting custom-integrated solution.

In many cases customers have tried the common product line approach as the basis of a solution to their interoperability problem, and have found it wanting.

The bottom line is that products that are certified to support open standards are necessary to realize Boundaryless Information Flow.

2.2 Business Scenario—How Used?

The Open Group helps IT customers and suppliers alike to realize the vision of the Boundaryless Information Flow by means a two-fold strategy.

- Enable IT customers and suppliers to share a common understanding of the requirements of customers for interoperable solutions. This enables the supply side to construct the business case for creating interoperable products that reliably address those requirements, in both applications and infrastructure products.
- Deliver, to IT customers and suppliers alike, the assurance of interoperability.

This document (and others like it) forms part of the first element of this strategy.

Enterprises within a vertical industry sector such as Manufacturing often find they have many problems in common both in their applications suites and their IT infrastructures. In the Figure 1 below you see that many manufacturers have different manufacturing processes, different manufacturing process support business logic, and different metadata. However the evidence is that there is commonality in the scheduling, procurements, and human resources areas. As you will see below there is also commonality in the need for information to be shared throughout the entire environment.

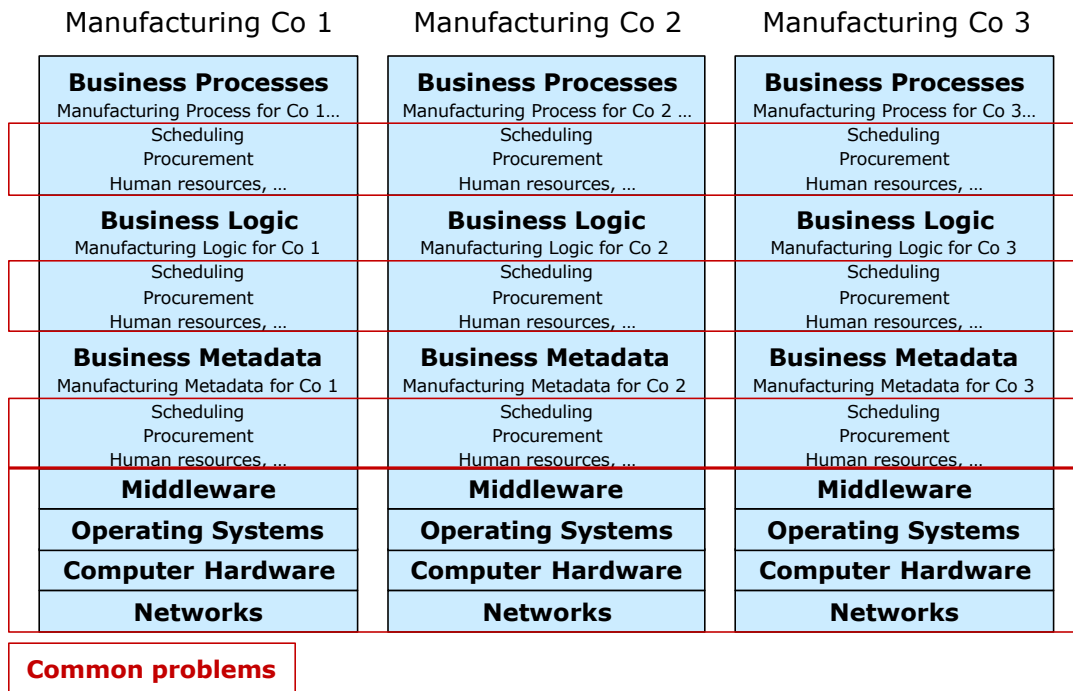

Figure 1: Common Issues in an Industry

The same similarities of problem are found in enterprises in very different vertical sectors such as Transportation, Finance, and Petrochemicals as depicted in Figure 2.

Figure 2: Common Issues Across Industries

Manufacturing	Banking	Petrochemicals
Business Processes Manufacturing Processes ... Scheduling Procurement Human resources, ...	Business Processes Banking Processes... Scheduling Procurement Human resources, ...	Business Processes Petrochemicals Processes... Scheduling Procurement Human resources, ...
Business Logic Manufacturing Scheduling Procurement Human resources, ...	Business Logic Banking... Scheduling Procurement Human resources, ...	Business Logic Petrochemicals ... Scheduling Procurement Human resources, ...
Business Metadata Manufacturing Scheduling Procurement Human resources, ...	Business Metadata Banking... Scheduling Procurement Human resources, ...	Business Metadata Petrochemicals ... Scheduling Procurement Human resources, ...
Middleware	Middleware	Middleware
Operating Systems	Operating Systems	Operating Systems
Computer Hardware	Computer Hardware	Computer Hardware
Networks	Networks	Networks
Common problems		

It is in these areas of commonality where we can make rapid progress.

The Open Group's members intend to develop from this work:

- A single, guiding, generic Business Scenario that captures interoperability issues that are common across most vertical sectors, and
- A suite of industry-specific scenarios – one for each vertical sector for which it can find CIOs and Chief Architects willing to collaborate – that elaborate on the aspects that are specific to the sector concerned.

This scenario and its companions will be placed in the public domain.

3 Business Scenario: The Interoperable Enterprise

Interoperability is very important to us, we integrate technology on the fly for a joint task force ...we get interoperable products that are cost effective out of the box so we get better products that we can integrate easily to provide capability to our war fighters. Dawn Meyerriecks, CTO, Department of Defense/Defense Information System Agency

Ms. Meyerriecks' statement highlights the need for products that work together readily and easily in support of a very important mission. It is not necessarily expected from day one that all products work together, but in a mission scenario, the unexpected often occurs. Shifting requirements may dictate that previously discrete products and systems now must work together of necessity. In that sense, Ms. Meyerriecks' challenge is very similar to the challenges in the commercial sector. Anticipating that the unexpected will shape the requirements for Boundaryless Information Flow, Ms. Meyerriecks and her counterparts in the private sector often cite the importance of open standards in mission critical systems.

3.1 Describing the Problem

A Problem Summary

This business scenario addresses the issue of gaining operational efficiencies through integrated information, and access to that information, in order to support the many different business processes of the enterprise - both internal external, spanning the key interactions of suppliers, customers, and partners.

The main technical challenge in addressing this problem of operational efficiencies is the lack of interoperability in two areas:

1. Between the different systems that generate and provide access to the data, and
2. Between different parts of the underlying IT infrastructure, whether these are based on COTS products or on custom-built solutions.

In practice the results of addressing this challenge are often technical kluges. These makeshift "solutions" not only represent greater IT cost - they are costly to develop initially, and lead to greater on-going maintenance cost - but also lead to greater business operational cost due to misrouting of supplies, services, personnel, and so on. In extreme situations, such system failures can lead to loss of life.

New approaches are being explored, but are often not compliant with open standards. Applying new technologies that are non-standard inevitably cause new pain - e.g., multiple portal infrastructures that are not interoperable, and that may actually conflict with each other. The Open Group's members see high value in looking at the approaches and necessary standards to help address the issues detailed in this scenario.

B Background

This Business Scenario reflects information gathered in two workshops and in follow-up analysis conducted in mid-2001. Contributions came from lead technologists and decision-makers at the following organizations:

- US Dept of Defense/DISA
- Petrotechnical Open Software Corporation
- Compaq Computer Corporation
- Lockheed Martin
- The Security Company
- Hewlett-Packard Company
- The Open Group

This scenario is the result of two workshops to gain an understanding of interoperability, or the lack thereof. To summarize, the description of the business scenario in each case could be characterized as: "Gaining operational efficiencies through integrated information, and access to that information, in order to support the many different business processes of the enterprise - both internal external, spanning the key interactions of suppliers, customers, and partners." Providing access to integrated information will support the interoperation of the business processes within the enterprise.

C Definition of Terms

Interoperability – The ability of two or more entities or components to exchange information and to use the information that has been exchanged "to meet a defined mission or objective." In this scenario this term specifically relates to access to information and the infrastructure that supports it.

Integration – The process of combining components into an effective overall system. In this scenario the phrase "access to integrated information" is used repeatedly. The term "integrated information" means an overall system in which a single view of information is presented, and is achieved by combining various information sources.

3.2 Pain Points

This Scenario describes how information managed by various applications in various environments needs to support operational and process efficiencies .

The main drivers for the scenario are the shared business needs to:

- Provide access to integrated information by staff, customers, suppliers, and partners, to support the business
- Provide higher quality products and service to customers
- Maintain the security and confidentiality of information.

In addition to the business drivers, there are often legal and regulatory requirements relating to access to information. A subset of these relate to the security and confidentiality of information, such as the safety requirements imposed by the US FAA on the national air transportation industry.

The main objectives of businesses in terms of information systems are typically to:

- Improve business process performance – If the process centers on logistics, then the performance metrics would be associated with the success of that process (e.g., were the supplies delivered?). If the process is about product lifecycle development, the metrics could be about budget, time, break even time, return on investment, etc.
- Decrease IT costs – Implementing a standards-based solution to the problems described in this business scenario will help remove redundancy and duplication in IT assets throughout the enterprise. It would also decrease the reliance on external IT service providers for integration and customization, and for subsequent maintenance, and will reduce the need for data translation between different formats used by different systems.
- Improve effectiveness of business operations – Lower overall IT costs means being able to allocate budget to new business features rather than “keeping things running”. This in turn will decrease the costs of running the business, decrease the time to market for the enterprise’s products, and increase the quality of its services to customers. Reducing the need for data translation will also improve the quality of business information and thereby increase business operations efficiency.
- Improve effectiveness of information technology organization – When information technology is a restraint not an enabler, service provision to users is poor, and IT changes are not implemented when the business needs them.
- Improve management efficacy – The information systems environment is often too complex to manage and not managed by a strategic architecture. This results in difficulty of balancing the short and long-term choices.
- Reduce risk – Complexity in the information systems environment makes it all the harder to implement effective security processes. Errors introduced into business processes through complex and faulty systems can lead to real world safety hazards, and even to loss of life.

Effective interoperable IT solutions can significantly contribute directly or indirectly to all the above objectives by avoiding the inefficiencies and inaccuracies of manually transferring information from one system to another.

Conversely, the customers represented in this business scenario indicate that the lack of interoperability in information technology generally causes the following “pain”, which effective interoperable IT solutions would address:

- Increasing IT cost without related improvement in productivity
 - redundancy and duplication in IT assets
 - increased maintenance cost
 - increased reliance on (expensive) external IT service providers
- Lack of effectiveness of IT in delivering required services to the business
 - poor service provision to users
 - IT changes not implemented when the business needs them
 - IT a restraint, not an enabler
- Resultant lack of effectiveness of business operations
 - increasing costs to run the business
 - increased time to market for the enterprise’s products and services
 - inability to provide effective services to customers
- Lost opportunity to add value to the business
 - non-discretionary spend rising, spend on extra business value decreasing
 - new features sacrificed just to “keep things running”
- Reduced management control
 - IT and business environment too complex to manage
 - IT not driven from strategic architecture
 - difficult to balance short and long term choices
- Increased operational risk
 - security
 - safety criticality
 - IT becomes a "choke point" - the business stalls

Not all organizations have all of these objectives and pain points, and the importance given to different each in different organizations varies. But every organization will have some of them.

3.3 Views of Environments and Processes

A Business Environment

Enterprises range from small, unified companies to large, complex, distributed organizations. Interoperability is important to them all, but the value increases with the organization's size and complexity. The organizations on whose experience this scenario is based are generally at the upper end of the complexity scale.

The key organizations and entities in the typical business environment – particularly those relevant to the processes discussed in this Scenario – are illustrated in the following figure.

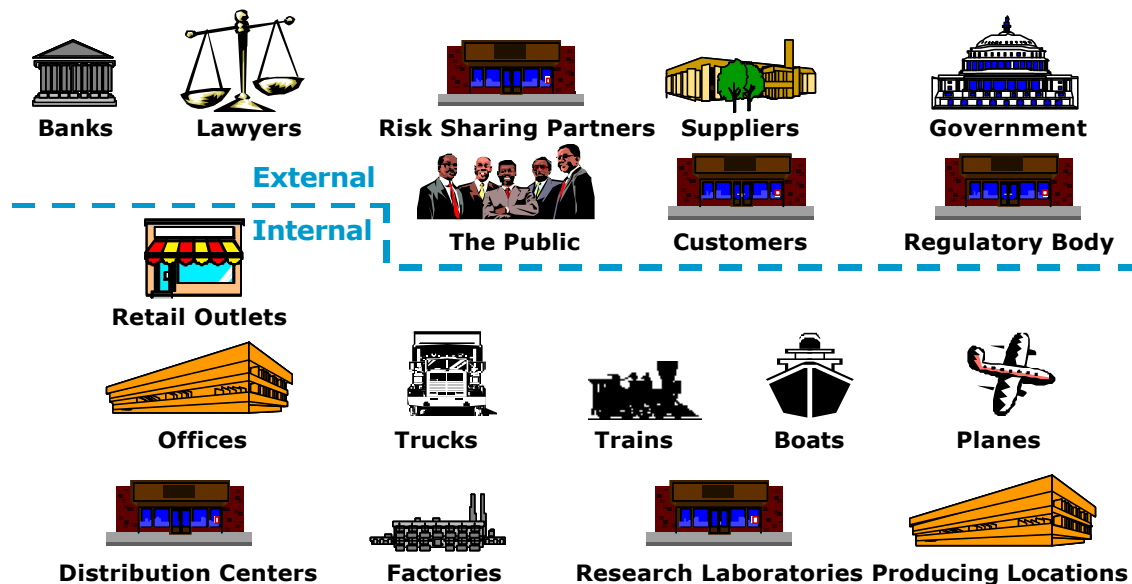

Figure 3: The Business Environment

Not all organizations will have all of these internal components and external relationships. But the figure can be used to bring out a number of points typical of complex enterprises, each of which has particular implications for interoperability. Points to note:

- The organization typically has a number of facilities of different kinds and in different locations. These include shops, offices, warehouses, factories, and laboratories. They may also include special-purpose facilities such as hospitals, oilrigs, and construction sites.

- In addition to fixed locations, an organization usually has users who are mobile . Users can roam between different locations inside and outside the organization.
- Organizations have business relationships with other organizations of various kinds, including customers, suppliers, risk sharing partners, banks, legal advisors, regulatory agencies, and government departments.
- As well as having established business relationships, an organization may interface with the general public .
- The shape of the organization and its business relationships can change dynamically .
- The distinction between those “inside” and those “outside” the organization may not be easy to make.

B Processes

The high level processes that are the subject of this scenario are numerous, but they fall into three general categories: buy side , internal , and sell side processes. Whether the processes are automated or assisted by people, they need to have access to information in order to work. Access to integrated information would significantly improve the execution of all these processes.

Process Categories	Subprocess
Buy side processes	Ordering Procurement Accounts payable Accounts receivable...
Internal processes	Logistics Manufacturing Competitive intelligence Production Assembling Delivery

Process Categories	Subprocess
	Product lifecycle...
Sell side processes	Sales Customer support Customer relationship management...

The following table maps the individual process categories to presumed environments, either business or technical environments.

High Level Processes	Environment mapping
Buy side processes	Deal with suppliers, the procurement organizations, and the accounting departments. Also in today's approaches collaboration services are used frequently to facilitate these processes, for example to obtain signatures of authority.
Internal processes	Deal with the internal employees of the organization across departmental boundaries. The organization can be a company or a government.
Sell side processes	Deal with users of the organization's products or services, be they customers of a private company or civilian beneficiaries of a government service.

C Technical Environment

The technical environment has hundreds or thousands of systems and equipment types that cannot be used together. Some of the systems are legacy systems and some are new. There is mission value in mapping the information in these legacy systems to current systems if the price is affordable. This is usually driven by the need to improve process efficiency. A new process requires the interoperation of multiple stove-piped systems to enable exchange of information with the various legacy systems.

Current solutions include translators and manual re-entry of data. Another solution approach is to reduce to a minimum the number of systems that perform similar functions. Another dimension of the environment is that of currency of information; existing information ranges from being very stale to being current in a real-time sense. Similar data sometimes have different levels of integrity, depending on where they are in the overall process. Finally some of the data are stored and carried around on laptops and desktops rather than in safe repositories (data stores).

The key entities in the technical environment relevant to the processes discussed in this Business Scenario are illustrated in Figures 4a and 4b. The fundamental driver is the need to improve business operations through new processes or improvements to existing processes. This is generating demands to integrate information from multiple sources of the same or similar type data, e.g. the multiple procurement systems or multiple requirements systems. Additionally the information is transferred from one system to another when operating new business processes under technologies such as process and workflow. Finally information is provided through access points to users such as customers, suppliers, and internal employees.

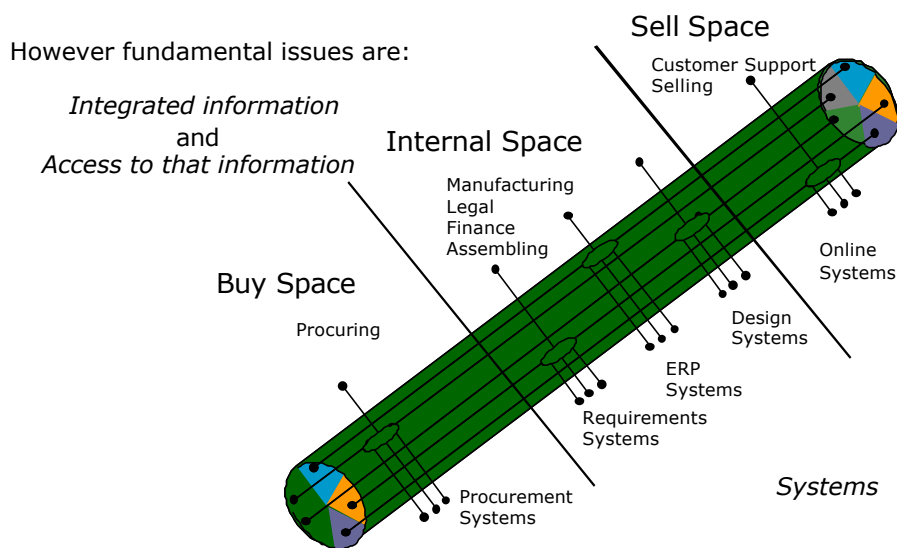

Figure 4a: The Technical Environment Integrated Information

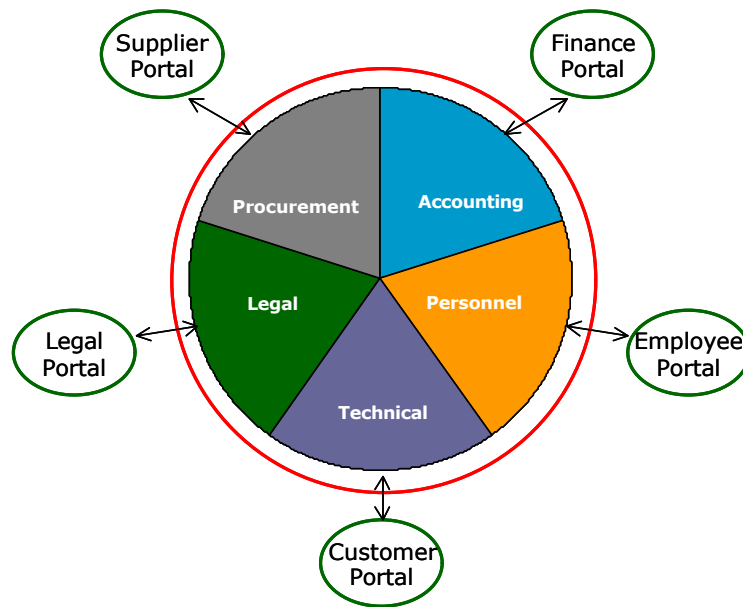

Figure4b: User Views- Access to Integrated Information

The systems will typically be a mix of systems specific to particular vertical domains and systems common to multiple vertical domains. In the manufacturing domain, for example, the product lifecycle processes typically include:

- product definition;
- manufacturing process design and definition;
- inbound logistics;
- workflow / shop floor logistics;
- outbound logistics (fulfillment/delivery);
- maintenance; and
- discontinuance

Systems that support enterprise functions common to a number of vertical domains typically include:

- personnel management
- workflow management
- finance
- procurement
- supply chain and catalog management

- customer relationship management.

All of these systems need to talk to each other.

Figure 5 provides a “network” view of the various components in an IT environment that has the types of issues outlined in this business scenario. The diagram shows the diversity of information technology within most organizations, i.e. that many departments have various types of servers and clients. The clients are also inside and outside the firewall indicating a need for access from either position. Network access is provided through external ISPs where needed.

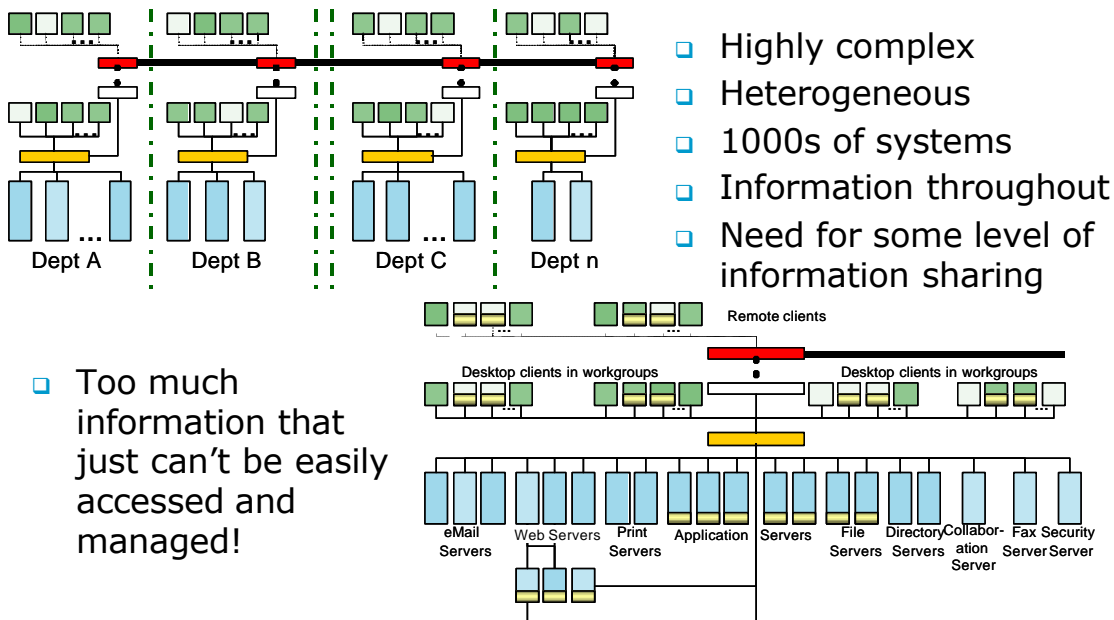

Figure 5: Network View of Technology Environment

Figure 6 depicts the detail of a typical department. Of importance here is the depiction of the numerous owners of the subject data; from the clients, desktops, applications servers, database servers, and file servers.

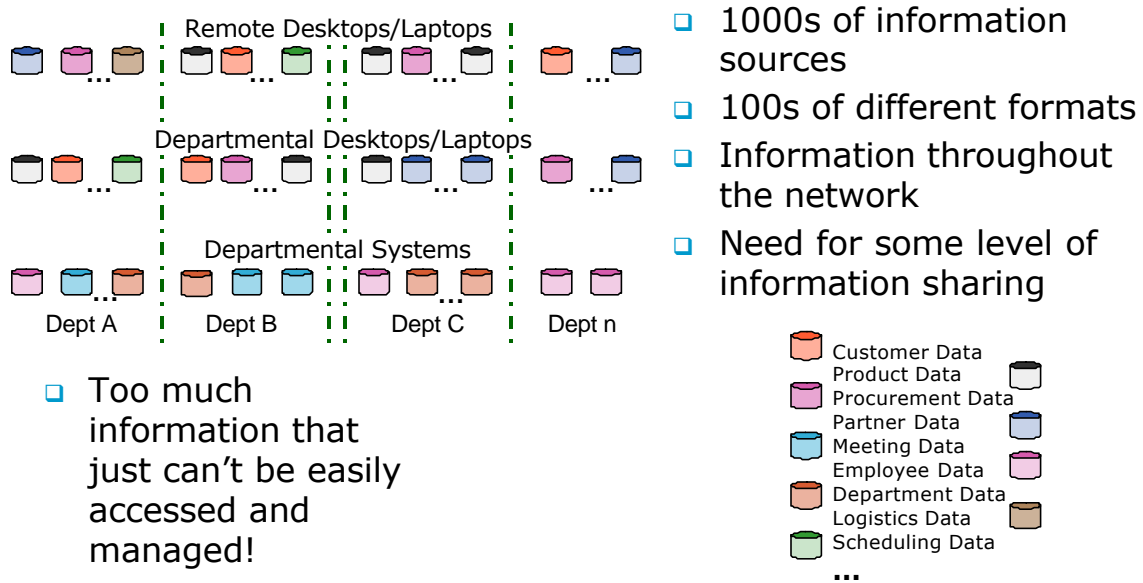

Figure 6:Information View

3.4 Actors and Their Roles and Responsibilities

A Computer Actors and Roles

The following table provides a very high level list of computer actors and their roles. The list is segmented into layers. Note that between client and server layers there appear to be overlap, e.g. web portal. In the client there is software that exposes the web portal to the user, in the server there is software that fulfills the requests from the client.

There is a fundamental assumption that the network can be “opened” through the appropriate use of routers, switches and networking protocol converters. This particular part of the problem is out-of-scope of this Business Scenario.

Computer Actors	Roles
Client – Runtime	
Human Interface	Client GUI, Web browser, Application windows. Provides the human to computer interface.
Client Applications	Provides the client side application specific functionality such as; access to web portals, mail, desktop video conference, streaming

Computer Actors	Roles
	audio/video, telephony, project management.
Client Services	Provide client side applications the services they need to provide application specific functionality to the user such as; messaging request, transaction processing, data Access, networking and communications.
Client Platform	Client OS and hardware platform
Network – Runtime	
Value Added Network Services	Provides services to multiple clients such as; messaging services, event brokering, component and object management, process and workflow control, enterprise application integration services, data interoperability services.
Network Security	Provides services to protect the integrity of the system such as; encryption, firewall services, intrusion detection services.
Network Platform	Provides a foundation for connecting multiple configurations of clients and servers such as; Network OS, routers, switches, hubs, ...
Server – Runtime	
Mail Servers	Provides multiple clients gateway services, inbound email services, outbound email services.
Telephony Servers	Provides multiple clients phone and facsimile services.
Web Servers	Provides multiple clients eForm services, proxy services, portal and personalization services, instant messaging services, stream audio/video services, commerce services, video conferencing services.
Application Servers	Provides server side applications an application execution environment, application support services, transaction management services.
Database Servers	Provides applications database access services, document management services, resource management services.
Directory Servers	Provides applications directory access and directory management services.

Computer Actors	Roles
Collaboration Servers	Provides client side applications services to promote collaboration of multiple users in a share problem space such as discussion groups, threads of discussion, white boards, ...
Security Servers	Provides services to protect the integrity of the system such as; authentication, authorization, and access control services.
File Servers	Provides access to file in a network environment such as ftp services.
Server Platform	Provides a foundation for server applications including operating system and the hardware platform.
Protocol Languages	
Protocols and Formats	Provides the means for open standard message formatting such as XML.
Development	
Tools	Provides the ability to define, design, develop, and deploy new applications such as; business modeling, design modeling and construction tools.
Management	
Utilities	Provides the ability to operate, administer, and manage the environment.

3.5 Resulting Technical Requirements

The following are high-level technical requirements driven from this Business Scenario.

- Openness – Standards-based open interfaces need to exist for critical interfaces to enable interoperability more easily and support integration of components. For example, the areas of protocols, web portal, collaboration, database, and storage connections would require standards based interfaces. Without open standards based interfaces, the implementation of web portals for access and storage solutions for integrated information will cause interoperability issues down the road.
- Data integrity – The same data are commonly stored in many places and in many formats. For example, a customer record may reside in multiple databases in multiple

places. The solution must support interoperability by translating as necessary between the multiple formats. (If height is stored in multiple places, then the solution must assure that when height is used, it is provided to the user—person or application—in the desired unit, e.g. feet, inches, meters, etc.

- **Availability** – The proposed solutions must be available 24/7/365 as business processes that must be available continuously are using these services. Where maintenance requires downtime, fallback services must be available.
- **Security** – The solutions must be able to support different security levels and protection based upon both the sensitivity of the data (whether or not the data are exiting the firewall) and the use of the data. Included are the normal requirements for data integrity, confidentiality, logging and tracking. The system security must provide flexible policy management to handle these situations. Additionally the solution must provide strong authentication yet provide users with single sign-on and user administration. PKI certificates are managed by either internal or external certification authorities.
- **Accessibility** – The solutions must provide global accessibility to the information without compromising security.
- **Manageability** – The solutions must be manageable.
- **Internationalization and Localization** – Because the solutions will be deployed around the world, they should be designed to accommodate multiple languages and adapt to cultural and technical requirements of specific countries.

3.6 Technology Architecture Model

A IT Principles

Solutions should be based on standards, which can be national, international, imposed by government regulation, or de facto. Market driven standards, which can include any of the types mentioned, reflect the need to assure new technologies can more easily allow for interoperation and integration in the future.

B Technology Architecture Supporting the Process

The following presents a software architecture that depicts the key components and subcomponents. Figure 7 depicts an architecture that supports the processes described in this business scenario. This software architecture was created as part of the analysis of the issues presented here. There is a back plane of key qualities that must be supported.

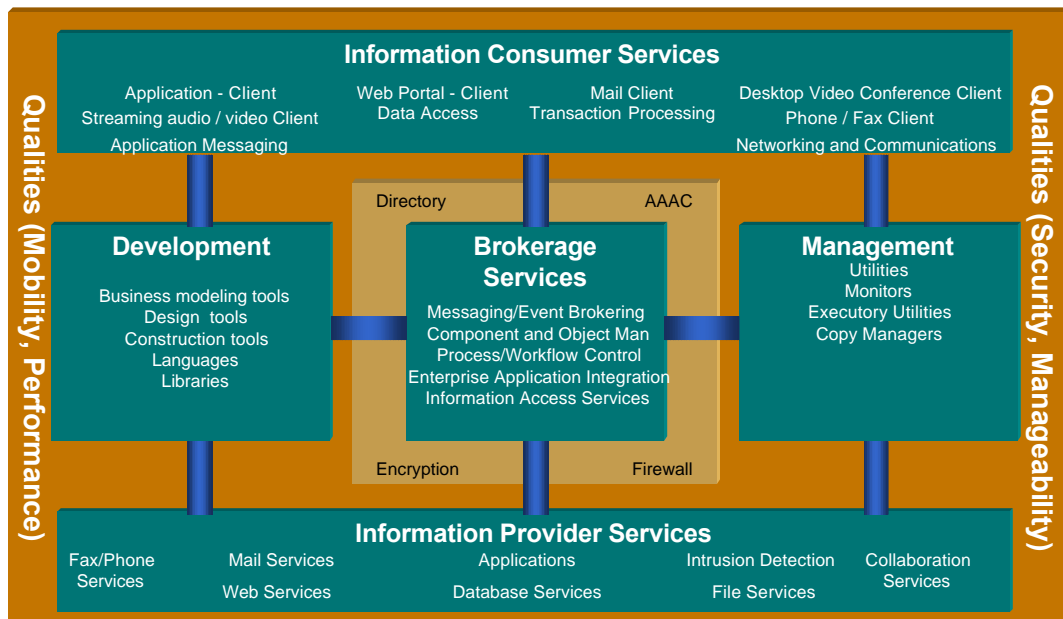

■ Classes of Interfaces - formats and protocols ...

Figure 7: Technology Architecture

3.7 Call to Action

At the heart of this effort is a new global initiative to create a trusted forum at the level of the CIOs and Chief Architects of the Fortune 500 and their equivalents around the world. The Open Group believes that a key responsibility of CIOs is to drive the task of standardization, so that standards initiatives are driven by the real business needs and requirements of the global IT customer community rather than by ad hoc technology trends and vested interests.

This document provides a vehicle to communicate business needs and requirements, and to articulate them in a common format. Through this The Open Group hopes to foster a common understanding of the requirements of IT customers for interoperable IT solutions, so that the supply side in particular will have the business case for creating the interoperable solutions in both applications and infrastructure products that address those requirements.

The business requirements must include measures. The measures that a business would use to determine if progress was being made in addressing the problems described in this business scenario are presented below. The following table suggests how The Open Group could support those measures through possible actions.

Business Measure	Support from The Open Group
Funding growth through consolidation	Providing standards and certification

Improving business operations, effectiveness of business operations more important than effectiveness of IT	of products that: <ul style="list-style-type: none"> • Provide consolidation of information • Provide access to information
Driving revenue growth	
Lower IT spend for the entire organization	
Increase % of procurements against standards	
Decrease spend on customizations	
Improved cycle time for rolling out upgrades	

An initial analysis of this business scenario has resulted in the identification of many possible areas of emerging technology, where The Open Group's strengths of providing a trusted, technology-neutral forum for customer/supplier dialog, standards integration to facilitate market growth, and acknowledged certification skills, can be brought to bear effectively. There are other alternatives that address access and integrated information and it is hoped that exposing this business scenario to public scrutiny will expose these alternatives. We encourage active participation to explore the alternatives and to establish the open standards that are required to deliver Boundaryless Information Flow.

For more information on The Open Group and to see how you can participate in the effort visit The Open Groups website at www.opengroup.org.

ⁱ Business Scenario tool is part of The Open Group Architecture Framework, available for download (registration required) at <http://www.opengroup.org/online-pubs?DOC=009008899>